

User's Guide

AXIS T8412 Installation Display

ENGLISH

About this Document

This document includes instructions for setting up and using the AXIS T8412 Installation Display.

Legal Considerations

Video and audio surveillance can be prohibited by laws that vary from country to country. Check the laws in your local region before using this product for surveillance purposes.

Electromagnetic Compatibility (EMC)

This equipment generates, uses and can radiate radio frequency energy and, if not installed and used in accordance with the instructions, may cause harmful interference to radio communications. However, there is no guarantee that interference will not occur in a particular installation.

If this equipment does cause harmful interference to radio or television reception, which can be determined by turning the equipment off and on, the user is encouraged to try to correct the interference by one or more of the following measures: Re-orient or relocate the receiving antenna. Increase the separation between the equipment and receiver. Connect the equipment to an outlet on a different circuit to the receiver. Consult your dealer or an experienced radio/TV technician for help. Shielded (STP) network cables must be used with this unit to ensure compliance with EMC standards.

USA – This equipment has been tested and found to comply with the limits for a Class B computing device pursuant to Subpart B of Part 15 of FCC rules, which are designed to provide reasonable protection against such interference when operated in a commercial environment. Operation of this equipment in a residential area is likely to cause interference, in which case the user at his/her own expense will be required to take whatever measures may be required to correct the interference.

Canada – This Class B digital apparatus complies with Canadian ICES-003.

Europe –  This digital equipment fulfills the requirements for radiated emission according to limit B of EN55022, and the requirements for immunity according to EN55024 residential and commercial industry.

Australia – This electronic device meets the requirements of the Radio communications (Electromagnetic Compatibility) Standard AS/NZS CISPR22.

Equipment Modifications

This equipment must be installed and used in strict accordance with the instructions given in the user documentation. This equipment contains no user-serviceable components. Unauthorized equipment changes or modifications will invalidate all applicable regulatory certifications and approvals.

Liability

Every care has been taken in the preparation of this

document. Please inform your local Axis office of any inaccuracies or omissions. Axis Communications AB cannot be held responsible for any technical or typographical errors and reserves the right to make changes to the product and documentation without prior notice. Axis Communications AB makes no warranty of any kind with regard to the material contained within this document, including, but not limited to, the implied warranties of merchantability and fitness for a particular purpose. Axis Communications AB shall not be liable nor responsible for incidental or consequential damages in connection with the furnishing, performance or use of this material.

RoHS

This product complies with both the European RoHS directive, 2002/95/EC, and the Chinese RoHS regulations, ACPEIP.



WEEE Directive

The European Union has enacted a Directive 2002/96/EC on Waste Electrical and Electronic Equipment (WEEE Directive). This directive is applicable in the European Union member states.



The WEEE marking on this product (see right) or its documentation indicates that the product must not be disposed of together with household waste. To prevent possible harm to human health and/or the environment, the product must be disposed of in an approved and environmentally safe recycling process. For further information on how to dispose of this product correctly, contact the product supplier, or the local authority responsible for waste disposal in your area.

Business users should contact the product supplier for information on how to dispose of this product correctly. This product should not be mixed with other commercial waste.

Support

Should you require any technical assistance, please contact your Axis reseller. If your questions cannot be answered immediately, your reseller will forward your queries through the appropriate channels to ensure a rapid response. If you are connected to the Internet, you can:

- download user documentation
- find answers to resolved problems in the FAQ database. Search by product, category, or phrases
- report problems to Axis support by logging in to your private support area.

AXIS T8412 User's Guide

This user's guide provides instructions for using the AXIS T8412 Installation Display.

- Overview - page 4
- Battery - page 6
- Power up - page 7
- Viewing Images - page 8
- Menus - page 10
- Setup - page 14
- Connect to an IP camera - page 11
- Snapshot function - page 16
- Network cable test - page 12
- AV in - page 12
- System setup - page 17
- Alternative connection methods - page 17
- Technical Specifications - page 18



ENGLISH

Important!
This product must be used in compliance with local laws and regulations.

Package contents

Item	Models/variants/notes
Installation Display	AXIS T8412
Power supply with power cable	12 V DC Adapter
Battery	7.4V Li-ion Battery Pack 2200mAh
Cables	<ul style="list-style-type: none"> • BNC Cable • Network Cable
Printed materials	AXIS T8412 User's Guide (this document)
Included accessories	<ul style="list-style-type: none"> • Soft carrying case • Terminator block • Car charger

Overview

AXIS T8412 is a battery-powered handheld device that greatly simplifies the field installation of both Axis network cameras and analog cameras. It displays live video from a camera and makes setting a camera's viewing angle and focus at the installation site easier than with the use of a laptop or remote computer. It offers user-friendly features such as touchscreen, zoom and snapshot functions. AXIS T8412 can connect directly to a camera, or to a network and search for Axis network video products. An Axis camera with built-in PoE support can even be powered directly by AXIS T8412, giving installers greater flexibility.

- **Simplifies setting the camera's viewing angle and focus**
The live video display and zoom functions help installers to adjust the field of view and set and test the camera focus.
- **Power over Ethernet for powering cameras**
AXIS T8412 delivers PoE to Axis network video products with PoE support either from the unit's battery or from PoE by-pass. This allows network cameras with PoE to be powered up and tested without extra tools or the need for electricity and network infrastructures at the installation site.
- **User-friendly**
AXIS T8412 Installation Display has user-friendly functions that greatly simplify camera setup. For example, the touchscreen monitor is simple and convenient to use at awkward installation locations. Full zoom in the image is via a simple tap on the touchscreen.
- **Snapshot function**
AXIS T8412 allows installers to take snapshots of images the network camera delivers as proof of finalized installation. The snapshots from network cameras can be saved to USB, Micro SD card, or AXIS T8412.
- **Supports both Axis network video products and analog cameras**
AXIS T8412 Installation Display supports Axis network cameras and encoders, as well as analog cameras through a BNC connector. AXIS T8412 is shipped with both an Ethernet cable and a BNC cable.

Hardware overview

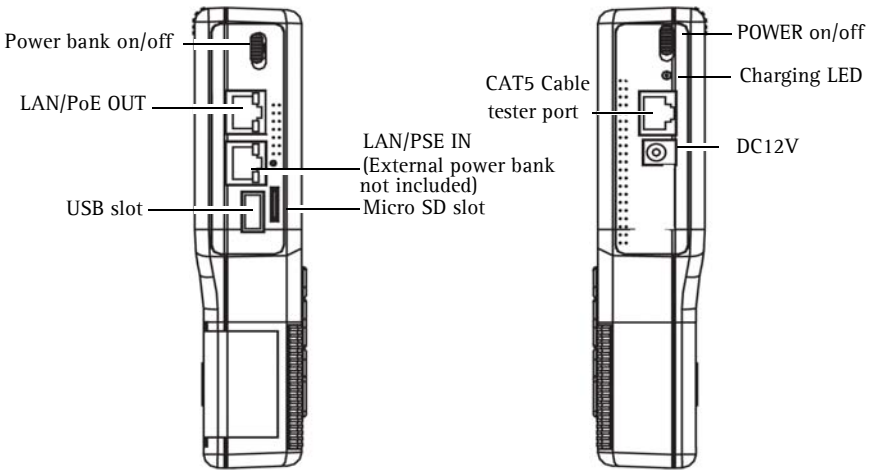
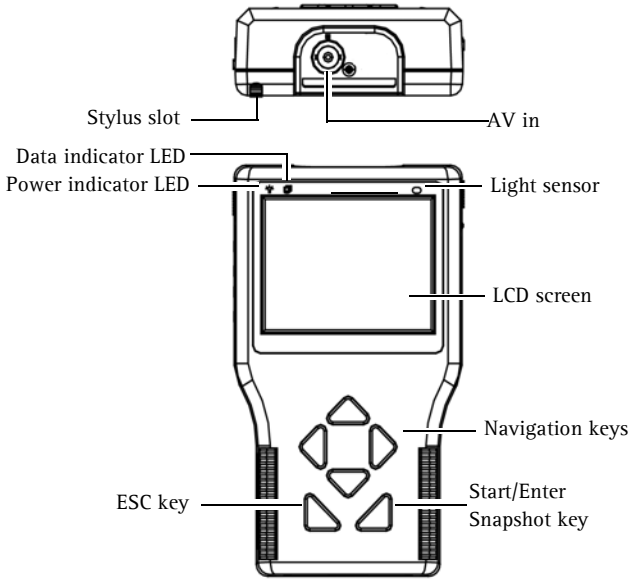

Unit connectors

LAN/PoE OUT - RJ-45 Ethernet connector. Provides power to network cameras that are PoE enabled.

LAN/PSE IN - The Power bank provides 48 V DC power (External power bank not included).

USB slot - Connect USB storage devices for data storage.



Micro SD slot - Insert a Micro SD card into the slot for data storage.

AV in - BNC connector for connecting an analog camera. Use a 75 ohm coaxial video cable.

CAT5 Cable tester - for testing and detecting wiring types. See *Network cable test*, on page 12 for instructions on testing wiring type.

Power Adapter - 12 V DC connector.

LED indicators

LED		Indication
Power		Power on indicator.
Data		Flashes when the AXIS T8412 is under operation
Charging		The LED will stay lit while the AXIS T8412's battery is charging.

Battery

The AXIS T8412 is powered by a rechargeable Li-ion battery pack that takes approximately 4 hours to charge, and provides the AXIS T8412 with up to 3 hours run time.



To open the battery compartment cover, press it while sliding it outward, as shown in the figure below.



When installing the battery, make sure that it is oriented correctly as shown in the figure.

During the charging process, the charging indicator will be lit.

Power up

1. To power up the AXIS T8412, first set the Power switch to the "ON" position.
2. Press the Start key and hold for 3 seconds.
3. The Power indicator lights, and a progress bar is displayed on the screen.
4. The Data Indicator blinks
5. The main menu will appear within 45 seconds.

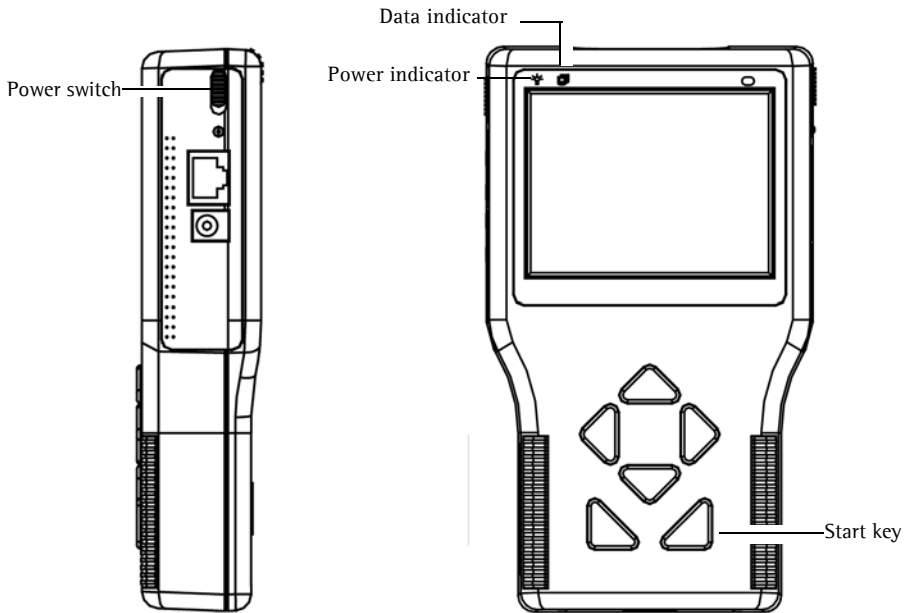

Viewing images

With AXIS T8412 Installation Display you can connect to a camera either through **Connect** or **Device Search** for viewing images, see **Connect** and **Device Search**, on page 11. The default view from the camera is at a relatively low resolution. When zooming into the view (see **Digital zoom** below) the camera's own default resolution is used instead, to provide greater detail.

Press the **ESC** key on the AXIS T8412 front panel at any time to exit the viewing screen.

Digital zoom, PT mode, and Flip view - all cameras

Zoom - Tap **ZOOM** on the screen for digital zoom. This will show the image at the camera's own default resolution, to allow fine adjustment of the focus.

PT Mode - While digitally zoomed into the view from the camera, the navigation keys can be used to move around in the image. The letters **PT** (Pan/Tilt) indicate that this is enabled. The arrows and digits at the bottom of the screen indicate the current position.

Flip view - Press and hold the **Up** and **Down** navigation keys to flip the view 180 degrees. Press again to flip back again.

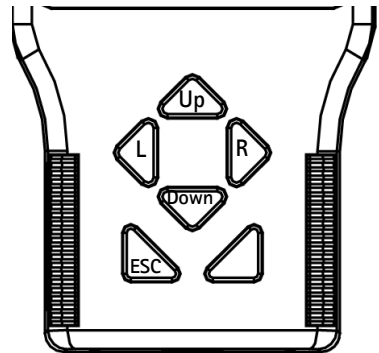

DC-Iris cameras

If the camera has a DC-Iris, this can be disabled for focusing by holding down the **L** and **R** navigation keys at the same time. Repeat to enable the DC Iris again.

Remote focus cameras

For cameras that support remote focus, this is controlled by the following:

- Press and hold the **L** and **R** navigation keys to start the focus procedure. This also automatically disables the DC-Iris. Press and hold the **L** and **R** keys again to re-enable the DC-Iris.
- Press and release the **L** or **R** key for single small focus steps.
- Press and hold the **L** or **R** key for continuous large focus steps.

When digitally zoomed into the image, tap the **ZF** (Zoom/Focus) indicator/switch to switch to **PT** (Pan/Tilt) mode.

Cameras with optical zoom

For cameras that support optical zoom, this is controlled by the following:

- Press and hold the **Up** or **Down** navigation key for continuous optical zoom, in or out.
- Press and release the **Up** or **Down** navigation key for optical zoom in single steps, in or out.

When digitally zoomed into the image, tap the **ZF** (Zoom/Focus) indicator/switch to switch to **PT** (Pan/Tilt) mode.

PTZ cameras











When connected to a mechanical PTZ camera, the PTZ functions can be controlled by the following:

- Tap the direction arrows on the screen to pan and tilt the view.
- Press and hold the **Up** or **Down** navigation key for continuous optical zoom, in or out.
- Press and release the **Up** or **Down** navigation key for optical zoom in single steps, in or out.

Tap **ZOOM** on the screen for digital zoom, which will show the image at the camera's default resolution. Since the camera has mechanical Pan/Tilt functionality, the digital PT mode is not available.

Menus - Main menu



Button	Function
	Main Menu.
	Return, go to previous page.
	Enter, opens a submenu or saves settings.
	PoE indicator
	Battery status
	Connect to an Axis network camera.
	View analog camera connected to AV IN connector
	CAT5 Network cable test
	PoE On/Off
	PoE Setup
	Setup menu



IP Camera



With AXIS T8412 Installation Display you can connect to a camera either through **Connect** or **Device Search**. If the IP address for the camera is not the default address expected, AXIS T8412 will change its own IP address so as to enable the connection. This may take a few seconds to complete.



Connect

From one of AXIS T8412's LAN ports connect a network cable to the camera's network port. From the Main menu tap **IP Camera** and **Connect**. **Waiting** will appear on the LCD display. When the camera is connected successfully, its image will display in the screen.



Device Search

Device search can be used to find all cameras in a local network or a single camera directly. To find cameras on a local Network, connect AXIS T8412 to the LAN with a network cable from one of the LAN ports. Tap the **Device Search** icon to show the list of cameras found. Tap the IP address of the target camera, enter its Username and Password if different from the default. Tap the **Enter** icon or the **CONNECT** button. The camera's image will display in the screen.

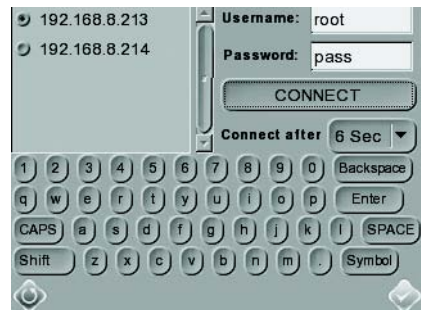

Press the ESC key on the AXIS T8412 front panel to exit the viewing page.



Configure Root Password

This setting allows you to specify a password for the user "root", which will be used to access all new or factory defaulted cameras. If an individual camera uses a different password, this should be directly entered when accessing that camera instead.

Use the keyboard to tap in the **Username** and **Password** and tap **Set Password**.

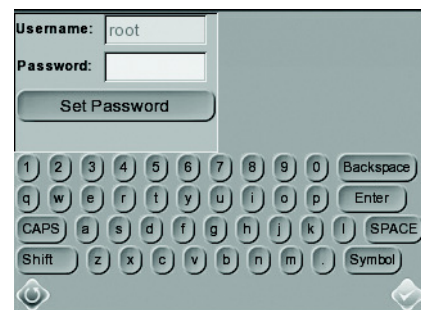

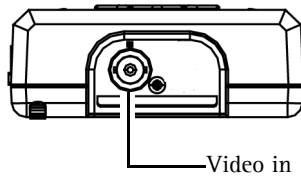
 **AV In**

Test analog video by connecting the BNC cable from the camera's video output to the AXIS T8412 video input port. Tap the **AV In** icon in the Main Menu, and the video signal will be displayed on the LCD screen. Press the ESC key to return to the menu.

To adjust the contrast in the image, go to **Setup > Setup AV**.

 **Network cable test**

Follow these steps to test a network cable for type; straight or cross, and for errors; open, short or miswire.

1. Connect one end of the network cable to the supplied CAT5 Network terminator and the other end to the CAT5 port.
2. Tap the CAT5 icon in the Main menu
3. The cable's wire map will be displayed on the screen.

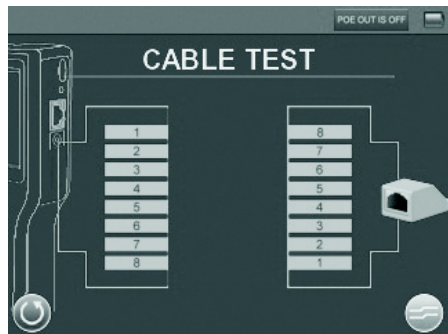



Power over Ethernet

AXIS T8412 delivers PoE to Axis network video products with PoE support either from the unit's battery or from PoE by-pass. Tap this icon to turn on and off the Power over Ethernet.



PoE Setup

To enable that PoE starts as soon the AXIS T8412 itself is powered up, select **ON** from the drop-down list. To limit the amount of time that PoE will be enabled when there is no camera connected, select the number of seconds from the **PoE auto-shutdown after drop-down** list.

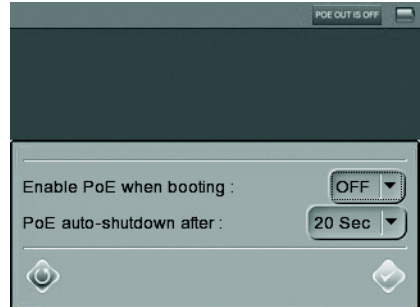

SETUP

Under SETUP are the menus for IP, AV, System, and Snapshot



Setup - IP



Setup -IP connection

These settings are optional and advanced. In most situations the you will not need to change them. The settings that cannot be changed are intended for future use. Leave other settings as they are, unless specifically required.

1. Tap the **Setup- IP connection** icon. Enter the information in each field using the stylus.

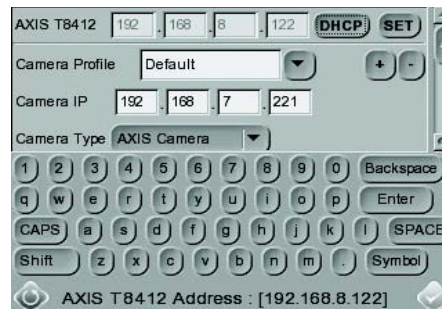

AXIS T8412 - The IP address can be set to DHCP or to a fixed address. DHCP is the default setting and should be used in most situations, even when there is no actual DHCP server available via a network. The IP address is grayed out when set to DHCP. To set a fixed address, tap **Set**, change the IP address and then tap the **Enter** icon.

Camera Profile - this allows you to store camera configurations so that they can be recalled later. Select a profile from the list, or change the name and settings.

Camera IP - enter the network camera's IP address.

Camera Type- AXIS Camera (by default)

User Name - enter the user name for the camera. By default Axis' products have "root"

Password - enter the password for the camera. By default Axis' products use "pass". To reveal the password being entered, tap **Show**.

Management Port, **Streaming Port**, **Streaming Format**, and **Streaming Protocol** can be left at their default settings unless the camera has been set up with different settings.

2. To save a new camera profile, make changes and tap the "+" key. To delete a camera profile, find it in the list and tap the "-" key.
3. When finished, tap the **Enter** button and tap the **Return** button.

Note: If AXIS T8412 detects a camera with an IP address on a different subnet it will automatically change its own address so that a connection becomes possible.



Setup - IP camera

These settings are advanced and not normally required. To make particular settings for an individual camera, tap the **IP camera** icon and enter the network setting of a network camera.

Import Camera Type - used to import a text file containing camera configuration information from a USB memory stick.

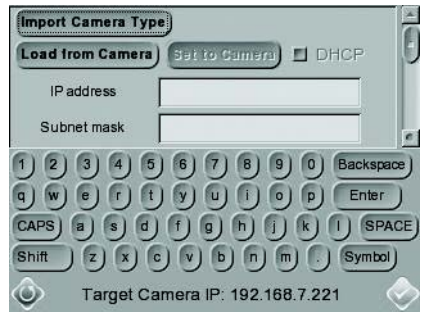

Load from Camera - Load the current camera configuration, which can then be modified and reloaded to the camera, using **Set to Camera**.



Setup - AV

Tap the **Setup - AV** icon to open the Video Display setup page, from where you can adjust video brightness, sharpness and contrast. Use the up or down keys on the AXIS T8412 front panel to move among the items, or tap the icon on the right-side of the value indicator. To adjust the value, press the left/right keys on the front panel or tap the slider in the page.

Tap the **Enter** icon to save the settings.



Tap this icon to switch between brightness, sharpness and contrast



Snapshot Function

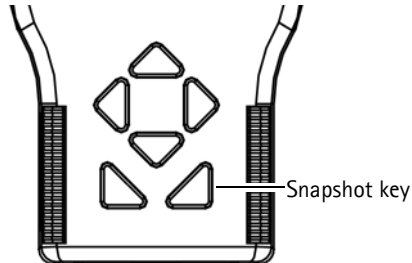

In the IP Camera viewing mode, press the Snapshot key on the AXIS T8412 front panel to save the current image

Edit

Once the Snapshot key is pressed, the Snapshot editing page will open. Choose a location to store the snapshot by tapping on T8412, USB or SD.

1. Enter a file name and description.
2. Tap Enter/Save icon and return to the viewing page.



File management

To manage snapshot files from the Main Menu tap the **SETUP** icon > **Setup-Snapshot**. Here you can preview, copy and delete images.

1. To view files, select the correct **Display Path**, T8412, USB or SD.
2. Available snapshot files are listed under **File List**.
3. To view a snapshot, tap the file name in the list and the image will appear in **Image Preview**.
 - **Copy** - Tap the **Copy** icon, select the location, and tap **Save**.
 - **Delete** - Select the file to remove and tap the **Delete** icon. Tap **OK** to complete the removal.
 - **Select all** - To select all files for copying or deleting tap the **Select all** icon.



Copy Delete Select all



System Setup

Tap the **Setup-System** icon to enter the AXIS T8412 System setup page. In this page, you can adjust the brightness of the screen, implement firmware upgrades and restore all settings of the AXIS T8412 to factory default.

Backlight Adjustment - Control the brightness of the AXIS T8412 screen by moving the slider of the Backlight value indicator. A higher value produces a brighter image.

Firmware Upgrade - When you upgrade your AXIS T8412 with the latest firmware from the Axis Web

site, your Installation Display receives the latest functionality available. Always read the upgrade instructions and release notes available with each new release, before updating the firmware.

1. Save the firmware files (*.tgz, *.tgz.md5) to a USB device in a folder named upgrade\upd_t8412s.
2. Tap the **Upgrade** button, to open the File Select dialog.
3. Tap the **USB** button and select the firmware upgrade file.
4. Tap the Enter icon.

Complete Update - Check this option if you would like a complete installation of every component in the firmware. If this option is not checked, only the changes in the firmware will be upgraded.

Restore to Factory Defaults - Restore the AXIS T8412 system to factory default by tapping the **Default** button,

Auto Shutdown - To save power, tap the drop-down list to choose the amount of idle time before AXIS T8412 shuts down.



ENGLISH

Alternative connection methods

External powerbank

Connect a camera to PoE out, connect a powerbank to PSE IN, set the Powerbank's switch to the ON position.

Technical Specifications

Function/group	Item	Specification
	Model	AXIS T8412 Installation Display
Display	Color LCD Field Display	3.5 inches
	Resolutions	320x240
Video	Image settings	Autosensing
Network	IP Setting	<ul style="list-style-type: none"> • Static IP address • DHCP
General	Casing	ABS plastic
	Memory	128 MB RAM (16 MB available for snapshots)
	Power	<ul style="list-style-type: none"> • 12 V DC +/- 10%, 1 A • CANON BP-915 (7.4 V 2000 mAh) 80% capacity after 300 charge cycles Charge time 3.5 Hrs Operation time 3 Hrs with PoE off, 2 Hrs with PoE on.
	Connectors	<ul style="list-style-type: none"> • BNC Video in • RJ-45 10BASE-T/100BASE-TX PoE IEEE 802.3af • CAT-5 • USB 2.0 • PoE
	Operating conditions	0 – 50 °C (32 – 122 °F) Humidity 20 – 80% RH (non-condensing)
	Local Storage	SD/SDHC memory card slot (card not included)
	Approvals	<ul style="list-style-type: none"> • USA/FCC Class A • Europe/CE Class A
	Dimensions (HxWxD)	170 x 99 x 38 mm (6.7" x 3.9" x 1.5")
	Weight	450 g (0.99 lb.)
	Included accessories	<ul style="list-style-type: none"> • Soft carrying case with sunshield • Protective rubber sleeve • Built-in stylus • Terminator block for CAT-5 Cable test • CAT5 Network cable • BNC cable • Car charger 12 V DC • Power supply

User's Guide

Ver.1.00

AXIS T8412

Printed: December 2009

© Axis Communications AB, 2009

Part No. 37081